



**HOT ROLLED STEEL SHEETS, PLATES AND COILS**  
**Mechanical cutting**



It is recommended that high strength steels are mechanically cut by guillotine shears. Especially, when mechanically cutting the steel grades Optim 700 MC, Optim 700 ML, Optim 900 QC, Optim 960 QC, Raex 400, Raex 450 and Raex 500, the cutting machines and their set values should be chosen carefully. The most important factors are clearance and cutting angle. The hardness of the cutting blade also has a substantial effect on the cut, especially when shearing hardened Raex steels. Hardened Raex 400 steel can be cut with robust heavy-duty shears with correct blade clearances. Blade hardness must exceed 53 HRC. Mechanical cutting of Raex 500 steel is recommended only when the plate thickness is less than 10 mm.

The clearance affects on the service life of the cutter blades and therefore on the cutting costs. A suitable clearance reduces the stresses subjected to the cutter frame. This prolongs the usable life of the shears, and allows cutting of thicker plates. Luckily setting the clearance is a quick, measurable and controllable operation. When cutting high strength steels, the clearance needs to be increased. With particularly tough steels, the clearance must be strongly reduced to avoid folding and subsequent jamming of the plate between the blades. Furthermore it should be noticed that successful mechanical cutting of steel sheets and plates is largely based on empirical information on cutting operations in every individual workshop.

● **Plate temperature in mechanical cutting**

Regardless of the strength or the hardness of steel, successful mechanical cutting requires that the plate is allowed to warm up throughout to room temperature +20°C before cutting. Figure 1 shows the time needed for warming up, when a steel plate is brought inside from a subzero temperature. The measurements were performed for plates of three different thicknesses.

**Figure 1.**  
**The warm-up time of cold (-20°C) steel plates in a hall with a temperature between +20°C and +22°C.**

The test was performed at Rautaruukki in Raahе in February 2011. Plate sizes 12 x 1000 x 2000, 21 x 1000 x 1600 and 40 x 1000 x 2000 mm.

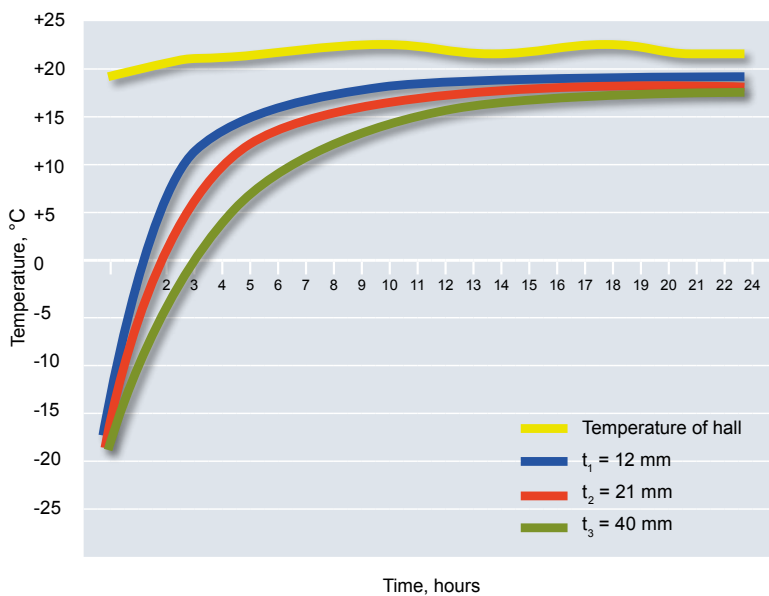

The test in figure 1 gave the following warming results from -20°C to +17°C:

- about 8 hours for a 12 mm plate
- about 12 hours for a 21 mm plate
- about 17 hours for a 40 mm plate.

The surface and the centre of the plate warm up at equal rates with such a slow change. It must be emphasised that large, thick plates stacked one on the other warm even more slowly. As a basic rule, it can be concluded that a cold plate (width 2 m, length 6 m) that has been stored outside in a subzero temperature warms to room temperature in about 24 hours.

- **Cutting geometry**

The factors affecting the cut with plate shears are shown in the main cutting plane and in the plane perpendicular to it, see Figure 2. The clearance ( $u$ ), cutting angle ( $\alpha$ ), angle of skew ( $\gamma$ ) and angle of tilt ( $\beta$ ) affect the cut. If the cutting angle ( $\alpha$ ) is zero, the cutting process is called blanking. This means that the upper and lower blades are parallel, and the entire width of the plate is cut at the same time. When the cutting angle is other than zero, the process is called guillotining. This is the most common and important process with straight-blade cutters. Rotary shearing is very similar to guillotine shearing as far as cutting geometry is concerned, and they are often considered to be equal processes. Clearance ( $u$ ) is the distance between the upper and lower blades. The clearance in cutting machinery can usually be adjusted within certain limits. In guillotine shears only the horizontal clearance between the blades is adjusted. In rotary shears, both the horizontal and vertical clearance ( $h$ ) is adjustable. The adjustment of the vertical clearance affects especially on the separation of the cut strip.

You can also affect the cutting result through the angle of tilt ( $\beta$ ) and angle of skew ( $\gamma$ ) values. When cutting narrow strips, the correct angle of tilt reduces cutting faults and at the same time slightly reduces the wear of the blades. Setting the angle of skew value between 1 and 2 degrees results in a straight, rectangular cut. With this setting, the clearance does not remain constant, but grows as the cutting proceeds.

**Figure 2.**  
**Mechanical cutting processes**

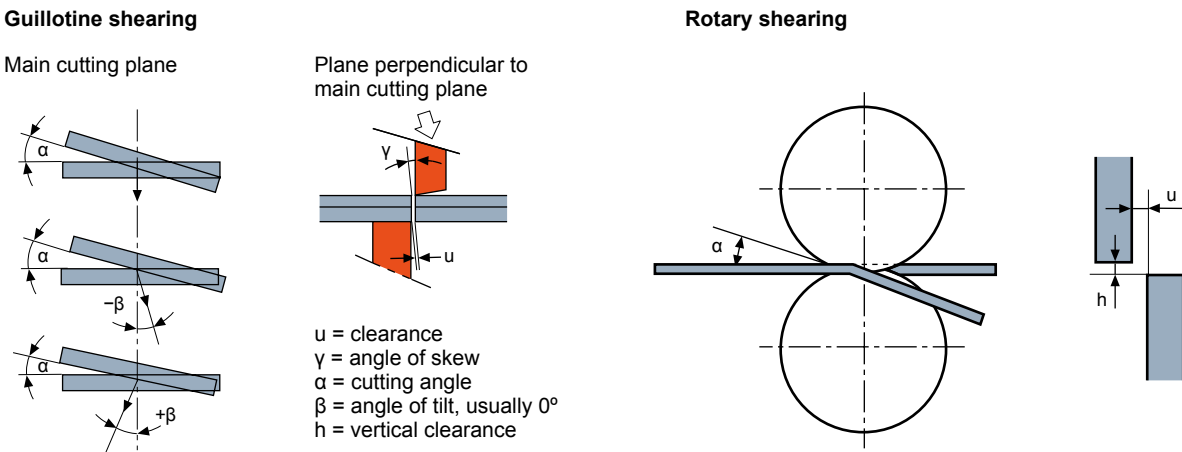

- **Cutting stages**

At the first stage of cutting steel yields elastically. After the yield strength of the material is exceeded, plastic deformation begins. As the cutting proceeds, the deformation capability of the steel is at certain point exceeded, and a fracture follows. At the final stage of cutting the fractures starting from the point where upper and lower blades press the material meet.

On the cut edge the different stages of cut can be seen, Figure 3. At the beginning, a rounded corner is formed along the edge of the plate being cut, called a rough edge. This is formed by the upper blade on the top surface of the plate, and by the lower blade on the bottom of the cut piece. As the cutting proceeds, the blade penetrates into the plate to a certain depth causing a polished zone on the shear face. The fractured zone is formed next as described in the previous chapter.

At the final stage the burr is formed due to the greatest compressive stresses being directed from the upper blade diagonally towards the cutting edge of the lower blade. This causes a transversal stress into the material yielding in the cutting zone, which improves the deformation capability of the material. Therefore the plate does not fracture exactly at the planned cut line, but beside it, where the material has work hardened to a lesser degree. The plate is fractured only after sliding past the cutting blade. A sharp protrusion, the burr, is formed on the cut edge along the cutting line.

**Figure 3.**  
**Parts of the shear face**

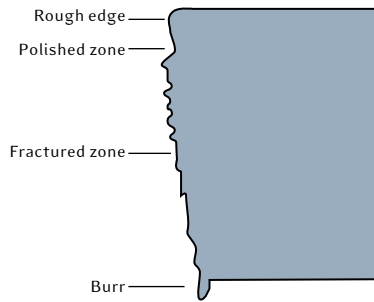

● **Evaluation of the cut and possible faults**

The cutting result is evaluated based on:

- the form and dimension accuracy of the cut piece,
- the appearance of the cut edge and
- the height of burr.

The end result is affected by the cutting machine and the steel being cut. The crucial factor in the steel is its tensile strength. The toughness of the steel, particularly its deformation capacity, affects also the cutting result.

The major factors causing cutting faults are:

- too big cutting angle,
- blunt blades,
- inappropriate clearance adjustment and
- excessive bending of the frame and axles in the cutting machine.

Three different types of faults are seen in a cut strip of steel. These, together with the rectangularity and flatness of the cut edge determine the cutting result.

The fault types are, see Figure 4:

- twist,
- camber and
- bow.

**Figure 4.**  
**Fault types in a cut steel strip**

**Bow**

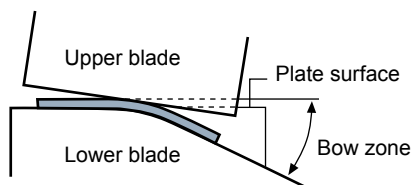

Reasons for bow and twist:

- large angle of tilt
- internal stresses in plate
- slow cutting speed
- thick plate
- soft material
- narrow strip to be cut
- long workpiece

**Twist**

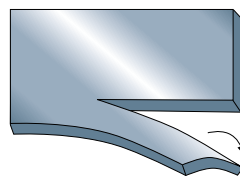

**Camber**

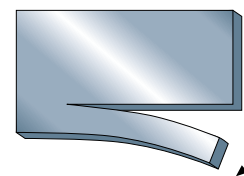

Reasons for camber:

- internal stresses
- large angle of tilt
- bending of cutter's steel beam
- small clearance

- **The effect of clearance on cutting**

When cutting steel, only part of the material is cut. The rest is separated by fracturing, as discussed earlier. The angle of fracture remains the same when cutting the same steel grade. This is why the clearance is set according to the thickness and tensile strength of the plate.

In Figure 5, detail 5a, the clearance ( $u$ ) between the blades is too large. The fracture does not exactly meet the cutting edges of the blades, resulting in a discontinuous zone. This causes burr on the cut edge and excessive blade wear. In addition, the plate bends before breaking. The result is a cut edge with strong protrusions.

In detail 5b, the clearance ( $u$ ) is too small. The end points of the fracture end up in the middle of the blades, meaning that, in practice, the blades need to cut the plate twice. This causes extra strain to the cutting machine and may lead to blade failure. Too small clearance leads to an increased proportion of the polished zone in the cut edge and a reduced proportion of the fractured zone. As the clearance increases, the polished zone becomes smaller and the fractured zone larger. Too small clearance causes dough-like bumps on the cut edge, and they appear the easier the softer the steel is.

In detail 5c, the clearance ( $u$ ) is set correctly. The fracture meets the cutting edges of the blades exactly. The plate is cut straight, and no extra energy is needed. The cut edge is slanted with the same angle as the fracture angle. With a correct clearance, the cut edge looks planar and the proportion of the polished zone is approximately 20% of the cut edge. In rotary shearing, the vertical clearance ( $h$ ) is adjusted by moving the axes on which the blades sit. The most noticeable effect of the vertical clearance is how easily the cut strips separate from each other.

**Figure 5.**  
**Affect of clearance ( $u$ ) on cutting**

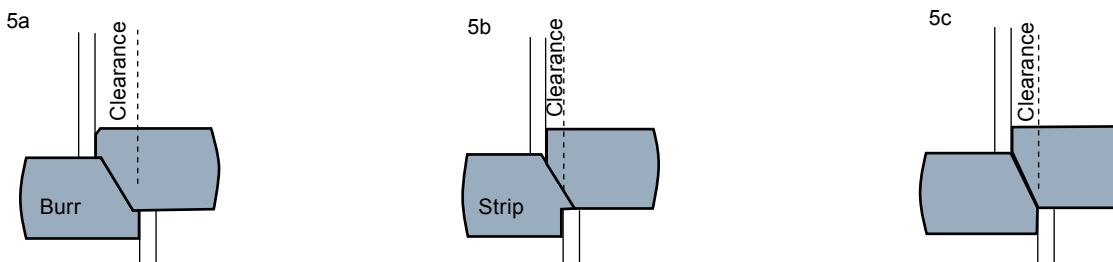

It is advisable to keep the vertical clearance as large as possible, as this causes the least wear to the blades. If the vertical clearance is too small, it causes a protruding edge because the plate is then lifted to run on top of the lower discs.

- **Clearance variations in rotary shearing**

During cutting, some deviation in placement of rotary shears occurs very often. Sometimes the rotary shears move on the axle so that the originally set clearance changes. The deviation in clearance can be as big as one millimeter. Deviations in clearance during cutting cause quality fluctuation in the cut edge, because the clearance may be both too large and too small during the cutting of the same plate.

The deviation of the clearance is often caused by inadequate tightening of the shears or impurities on the surfaces of the shims used for clearance setting. Mechanical faults in the cutting machine may also cause deviation in a set clearance value.

- **Clearance recommendations in guillotine and rotary shearing**

Based on experiments, the clearance values presented in Table 1 can be recommended. However, one should take into account the machine specific flexibility in the blade holder and in the frame of the machine, the plate retention force, the condition of the blades and the angle of cutting and skew, which, in addition to the clearance, affect the appearance of the cut edge.

Plate thickness is also of importance when determining the clearance. In particular, this can be seen in the values for yield strength class 355 MPa. For 6 mm thick plates, a clearance of 8 - 10% of plate thickness is sufficient, whereas a 10 mm thick plate requires a 10 - 15-per cent clearance. The values in the table are suitable for a plate thicknesses range of 6 to 10 mm.

**Table 1.**  
**Guillotine shearing. Recommended clearance values**

	Standard	Clearance % of plate thickness
S235J0	EN 10025-2	5 – 8
Ruukki Laser 250 C	Ruukki	5 – 8
Ruukki Laser 355 MC	Ruukki	5 – 8
S355J2	EN 10025-2	8 – 15
Multisteel	Ruukki	8 – 15
S355NL	EN 10025-3	8 – 15
Optim 650 MC	Ruukki	approx. 10

Rotary shears use slightly larger clearances than guillotine shears. The clearances given in Table 2 are suitable for plate thickness range of 2 to 20 mm. It should be noted that the adjustment of the vertical clearance in rotary shears affects the horizontal clearance to some extent.

**Table 2.**  
**Rotary shearing. Recommended horizontal clearance value**

	Standard	Clearance % of plate thickness
S235J0	EN 10025-2	15 – 26
Ruukki Laser 250 C	Ruukki	15 – 26
Ruukki Laser 355 MC	Ruukki	17 – 28
Multisteel	Ruukki	18 – 27
Optim 650 MC	Ruukki	20 – 29

The clearance values given for rotary shears (u and h) are actual clearances during cutting. Any flexibility in the cutter should be deducted from these values. The vertical clearance for an individual cutter may best be determined by increasing the vertical clearance as long as the cutter can still separate the cut pieces from each other. Some recommended vertical clearance values (h) are shown in Figure 6.

**Figure 6.**  
**Rotary shearing. Recommended vertical clearance (h) values**

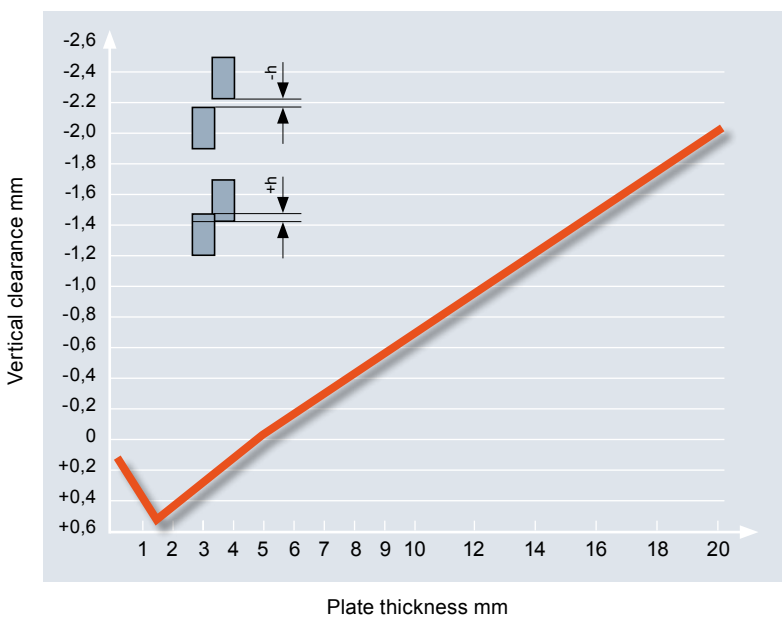

Ruukki is a metal expert you can rely on all the way, whenever you need metal based materials, components, systems or total solutions. We constantly develop our product range and operating models to match your needs.

**RUUKKI**  
more with metals

Rautaruukki Corporation ✉ Suolakivenkatu 1, FI-00810 Helsinki, Finland  
☎ +358 20 5911 🌐 [www.ruukki.com](http://www.ruukki.com)

Copyright © 2011 Rautaruukki Corporation. All rights reserved. Ruukki, Rautaruukki, More With Metals and Ruukki's product names are trademarks or registered trademarks of Rautaruukki Corporation.